

GERSTEL
certified **SUPPLIES**



GRAPHPACK



GRAPHPACK® 2M connection technology

For the rapid and economical connection of capillary columns to GC Inlets and Detectors.

The components of the GRAPHPACK 2M connection technology are the GRAPHPACK 2M ferrule, the GRAPHPACK 2M adapter and the GRAPHPACK nut.

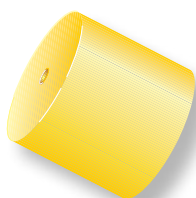

GRAPHPACK 2M ferrule

The GRAPHPACK 2M ferrule is a cylindrical metal cartridge packed with graphite.

Advantages

- Rapid and reliable installation/ changing of capillary columns.
- Rapid mounting and positioning of the ferrules on the capillary column outside the oven.
- Leak-free connections are achieved without excessive tightening.
- Connections remain leak-free with temperature cycling.
- Self-centering of the ferrule on the GRAPHPACK 2M adapter.
- The capillary column is always centered in the inlet or detector.
- No damage to column coating.
- Economical, no more than two ferrules are required for the life of a column.

GRAPHPACK 2M Adapter

Available for all column outside diameters between 0.2 mm and 0.8 mm.

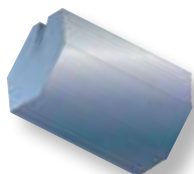

GRAPHPACK nut

A slotted nut for securing the column to all GRAPHPACK adapters.

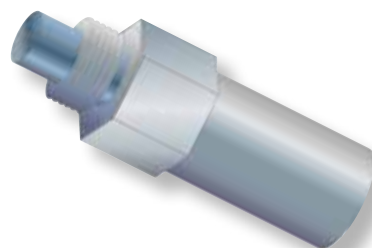

Column OD / ID Part No.

GRAPHPACK 2M ferrules

1 package (10 units)

0.20 mm / ≤ 0.1 mm	001805-020-00
0.25 mm / ≤ 0.1 mm	001805-025-00
0.31 mm / 0.20 mm	001805-031-00
0.40 mm / 0.25 mm	001805-040-00
0.45 mm / 0.32 mm	001805-045-00
0.70 mm / 0.53 mm	001805-007-00
0.80 mm / 0.27 mm	001805-008-00



GRAPHPACK 2M plug ferrule

1 package (5 units)

0.31 mm / 0.20 mm	011654-031-00
0.45 mm / 0.32 mm	011654-045-00
0.70 mm / 0.53 mm	011654-007-00

GRAPHPACK 2M mounting tool kit

For mounting and positioning of GRAPHPACK 2M ferrules on capillary columns.



Complete kit **006829-000-00**

Spare parts

GRAPHPACK mounting tool for GRAPHPACK 2M ferrules

tool body, without insert

004938-000-00



Column OD / ID

Inserts

≤ 0.31 mm (red)	006828-031-00
0.40 to 0.45 mm (green)	006828-045-00
0.70 to 0.80 mm (black)	006828-008-00



GRAPHPACK nut

for mounting tool
1 package (5 units)

000980-005-00



OD = Outside diameter
ID = Inside diameter

GRAPHPACK® 2M adapters with Swagelok® thread, female

For the conversion of GC systems with Swagelok fittings to GRAPHPACK 2M technology.



with 1/4" Swagelok female thread

Column OD / ID

Part No.

0.31 mm / 0.20 mm	006835-031-00
0.45 mm / 0.32 mm	006835-045-00
0.70 mm / 0.53 mm	006835-007-00



with 1/8" Swagelok female thread

0.31 mm / 0.20 mm	006834-031-00
0.45 mm / 0.32 mm	006834-045-00
0.70 mm / 0.53 mm	006834-007-00

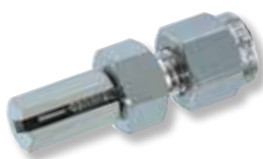

with 1/16" Swagelok female thread

0.31 mm / 0.20 mm	006833-031-00
0.45 mm / 0.32 mm	006833-045-00
0.70 mm / 0.53 mm	006833-007-00

GRAPHPACK 2M adapters with Swagelok® thread, male

For the conversion of GC systems with Swagelok fittings to GRAPHPACK 2M technology.

	Column OD / ID	Part No.
with 1/4" Swagelok male thread	0.31 mm / 0.20 mm	006832-031-00
	0.45 mm / 0.32 mm	006832-045-00
	0.70 mm / 0.53 mm	006832-007-00



with 1/8" Swagelok male thread	0.31 mm / 0.20 mm	006831-031-00
	0.45 mm / 0.32 mm	006831-045-00
	0.70 mm / 0.53 mm	006831-007-00



with 1/16" Swagelok male thread	0.31 mm / 0.20 mm	006830-031-00
	0.45 mm / 0.32 mm	006830-045-00
	0.70 mm / 0.53 mm	006830-007-00



GRAPHPACK® 2M detector adapters

For the low-cost conversion of detector connections of various GC manufacturers to GRAPHPACK 2M connection technology.

Advantages

- Economical, only one sealing technology is used for all detectors.
- No contact with the inside of the detector because of accurate centering.



Agilent Technologies / Hewlett-Packard

HP 5890 A and Series II, Agilent 6850/6890 and Agilent 7820/7890 for FID, NPD

Column OD / ID	Part No.
0.31 mm / 0.20 mm	006508-031-00
0.45 mm / 0.32 mm	006508-045-00
0.70 mm / 0.53 mm	006508-007-00

Spare parts

Silver seal; 1 package (5 units)	003962-005-00
----------------------------------	---------------



Agilent Technologies / Hewlett-Packard

HP 5890 A and Series II and Agilent 6850/6890 for TCD, FPD

0.45 mm / 0.32 mm	006831-045-00
0.70 mm / 0.53 mm	006831-007-00



Chrompack 9000

0.31 mm / 0.20 mm	006831-031-00
0.45 mm / 0.32 mm	006831-045-00
0.70 mm / 0.53 mm	006831-007-00

Dani Detectors; M4

0.31 mm / 0.20 mm	008189-031-00
0.45 mm / 0.32 mm	008189-045-00
0.70 mm / 0.53 mm	008189-007-00

Spare parts

Silver seal; 1 package (5 units)	001383-005-00
----------------------------------	---------------



Fisons Series 8000, Trace, Tremetics, CE 5300, CE 8000

0.31 mm / 0.20 mm	008190-031-00
0.45 mm / 0.32 mm	008190-045-00
0.70 mm / 0.53 mm	008190-007-00

Spare parts

Silver seal; 1 package (5 units)	000976-005-00
----------------------------------	---------------



Part No.

O.I. Analytical PID

0.31 mm / 0.20 mm	008005-031-00
0.45 mm / 0.32 mm	008005-045-00
0.70 mm / 0.53 mm	008005-007-00

O.I. Analytical PFPD and XSD

0.31 mm / 0.20 mm	010375-031-00
0.45 mm / 0.32 mm	010375-045-00
0.70 mm / 0.53 mm	010375-007-00

Spare parts

Silver seal; 1 package (5 units)	005249-005-00
----------------------------------	---------------

Perkin Elmer

0.31 mm / 0.20 mm	008020-031-00
0.45 mm / 0.32 mm	008020-045-00
0.70 mm / 0.53 mm	008020-007-00

Spare parts

Vespel™ graphite ferrule; 1 package (5 units)	009999-092-00
---	---------------

Siemens RGC 0202

0.31 mm / 0.20 mm	008191-031-00
0.45 mm / 0.32 mm	008191-045-00
0.70 mm / 0.53 mm	008191-007-00

Spare parts

Silver seal; 1 package (5 units)	003962-005-00
----------------------------------	---------------

Shimadzu 14 A and 17 A

0.31 mm / 0.20 mm	008068-031-00
0.45 mm / 0.32 mm	008068-045-00
0.70 mm / 0.53 mm	008068-007-00

Spare parts

Silver seal; 1 package (5 units)	002841-005-00
----------------------------------	---------------

Shimadzu 2010

0.31 mm / 0.20 mm	006511-031-00
0.45 mm / 0.32 mm	006511-045-00
0.70 mm / 0.53 mm	006511-007-00

Spare parts

Silver seal; 1 package (10 units)	005249-005-00
-----------------------------------	---------------

Varian 3300 / 3400 / 3500 / 3600 / 3800 / 3900 & Saturn

0.31 mm / 0.20 mm	008192-031-00
0.45 mm / 0.32 mm	008192-045-00
0.70 mm / 0.53 mm	008192-007-00

Spare parts

Silver seal; 1 package (5 units)	001383-005-00
----------------------------------	---------------

Spare parts

for all GRAPHPACK adapters

GRAPHPACK nut; 1 package (5 units)	001268-005-00
------------------------------------	---------------

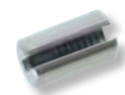
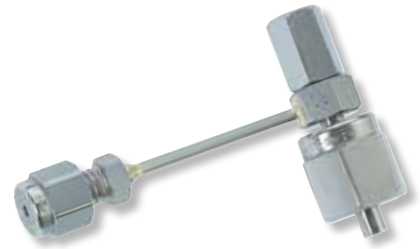

GRAPHPACK® 2M inlet adapters

For the low-cost conversion of inlet connections of various GC manufacturers to GRAPHPACK 2M connection technology.

Advantages

- Economical, only one sealing technology is used for all inlets.
- No contact with the inlet liner because of accurate centering.



Agilent Technologies / Hewlett-Packard

Split/splitless injector

HP 5890 A and Series II, Agilent 6850/6890 and Agilent 7820/7890

Column OD / ID

Part No.

0.31 mm / 0.20 mm	006509-031-00
0.45 mm / 0.32 mm	006509-045-00
0.70 mm / 0.53 mm	006509-007-00

Spare parts

Silver seal; 1 package (5 units)	001362-005-00
----------------------------------	----------------------



Agilent Technologies / Hewlett-Packard

HP 5890 A and Series II, Agilent 6850/6890 and Agilent 7820/7890 for TCD.

0.45 mm / 0.32 mm	006831-045-00
0.70 mm / 0.53 mm	006831-007-00



Fisons Serie 8000

Split/splitless injector

0.31 mm / 0.20 mm	007302-031-00
0.45 mm / 0.32 mm	007302-045-00
0.70 mm / 0.53 mm	007302-007-00

Sold without silver seal and nut.

Spare parts

Silver seal; 1 package (5 units)	007301-005-00
----------------------------------	----------------------



Perkin Elmer

PSS Injector

0.31 mm / 0.20 mm	008021-031-00
0.45 mm / 0.32 mm	008021-045-00
0.70 mm / 0.53 mm	008021-007-00

Spare parts

Vespel ferrule; 1 package (5 units)	009999-093-00
-------------------------------------	----------------------

Part No.

Perkin Elmer

Split/splitless injector

0.31 mm / 0.20 mm	007464-031-00
0.45 mm / 0.32 mm	007464-045-00
0.70 mm / 0.53 mm	007464-007-00

Spare parts

Vespel ferrule 1/4"; 1 package (5 units)	009999-091-00
--	---------------



Shimadzu 14 A, 17 A

Split/splitless injector

0.31 mm / 0.20 mm	008068-031-00
0.45 mm / 0.32 mm	008068-045-00
0.70 mm / 0.53 mm	008068-007-00

Spare parts

Silver seal; 1 package (5 units)	002841-005-00
----------------------------------	---------------



Shimadzu 2010

Split/splitless injector

0.31 mm / 0.20 mm	006511-031-00
0.45 mm / 0.32 mm	006511-045-00
0.70 mm / 0.53 mm	006511-007-00

Spare parts

Silver seal; 1 package (5 units)	005249-005-00
----------------------------------	---------------



Valco™ VICI Valve

0.31 mm / 0.20 mm	008019-031-00
0.45 mm / 0.32 mm	008019-045-00
0.70 mm / 0.53 mm	008019-007-00



**Varian
3300 / 3400 / 3500 /
3600 / 3800 / 3900 &
Saturn**

0.31 mm / 0.20 mm	008192-031-00
0.45 mm / 0.32 mm	008192-045-00
0.70 mm / 0.53 mm	008192-007-00

Spare parts

Silver seal; 1 package (5 units)	001383-005-00
----------------------------------	---------------



Spare parts

for all GRAPHPACK adapters

GRAPHPACK nut; 1 package (5 units)	001268-005-00
------------------------------------	---------------

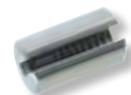

GRAPHPACK® 2M dual column inlet adapter

This dual column inlet adapter permits the simultaneous connection of two fused silica capillary columns to one inlet. This allows a sample to be analyzed on two columns simultaneously from a single injection. Adapters are available for GERSTEL® inlets as well as for all major GC manufactures.

Advantages

- Reduction in analysis time.
- Simultaneous analysis using capillary columns with different polarities.
- No split discrimination due to contact of the capillary column with the inside wall of the inlet liner thanks to column self-centering design.

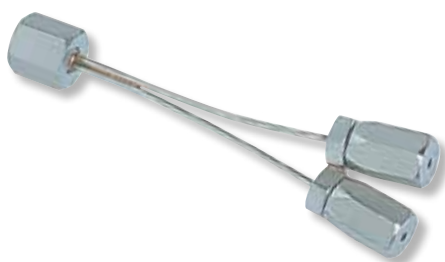
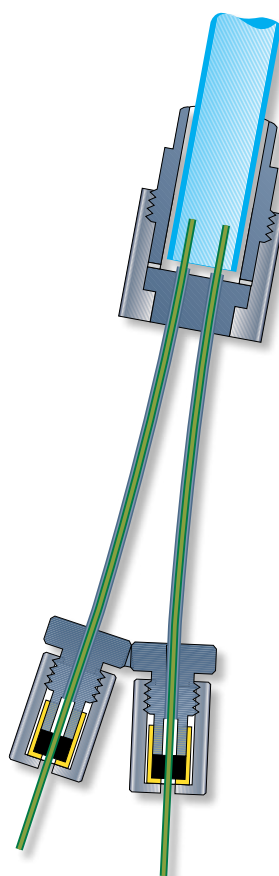

GERSTEL Cooled Injection System CIS 3, CIS 4 and CIS 6

Column OD / ID

Part No.

0.31 mm / 0.20 mm	007530-031-00
0.45 mm / 0.32 mm	007530-045-00

Spare parts

Silver seal; 1 package (5 units)	002841-005-00
----------------------------------	---------------

Column OD / ID **Part No.**

Agilent Technologies / Hewlett-Packard

Split/splitless injector
HP 5890 A and Series II, Agilent 6850/6890
and Agilent 7820/7890

0.31 mm / 0.20 mm	007533-031-00
0.45 mm / 0.32 mm	007533-045-00
0.70 mm / 0.53 mm	007533-007-00

Spare parts

Silver seal; 1 package (5 units)	001362-005-00
----------------------------------	----------------------

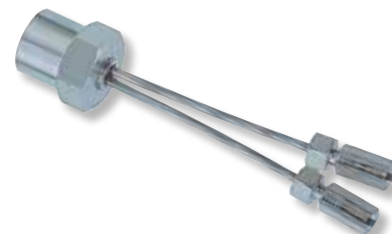

Fisons Serie 8000

Split/splitless injector

0.31 mm / 0.20 mm	008030-031-00
0.45 mm / 0.32 mm	008030-045-00
0.70 mm / 0.53 mm	008030-007-00

Spare parts

Silver seal. 5 mm OD; 1 package (10 units)	001402-010-00
Silver seal. 11.5 mm OD; 1 package (5 units)	007301-005-00



Perkin Elmer

Split/splitless injector

0.31 mm / 0.20 mm	007671-031-00
0.45 mm / 0.32 mm	007671-045-00
0.70 mm / 0.53 mm	007671-007-00

Spare parts

Vespel ferrule 1/4"; 1 package (5 units)	009999-091-00
--	----------------------

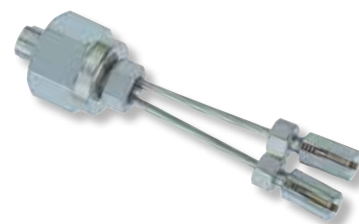

Carlo Erba CE 5300

0.31 mm / 0.20 mm	009040-031-00
0.45 mm / 0.32 mm	009040-045-00
0.70 mm / 0.53 mm	009040-007-00

Spare parts

Silver seal; 1 package (5 units)	000976-005-00
Silver seal; 1 package (10 units)	001402-010-00



GRAPHPACK® 2M MSD adapter

For the low-cost conversion of MSD connections of various GC manufacturers to GRAPHPACK 2M connection technology.

Advantages

- Economical, only one sealing technology is used for the capillary column.
- Leak-free at elevated or fluctuating temperatures and under high vacuum.

**Agilent Technologies /
Hewlett-Packard
MSD HP 5971 / 5972,
Agilent 5973A / 5973N /
5973 inert, 5975, HP GCD**



Column OD / ID

Part No.

0.31 mm / 0.20 mm	006511-031-00
0.40 mm / 0.25 mm	006511-040-00
0.45 mm / 0.32 mm	006511-045-00

Spare parts

Silver seal; 1 package (5 units)	005249-005-00
----------------------------------	----------------------

GRAPHPACK 2M dual column interface for MSD

For the simultaneous connection of two capillary columns to a single MSD

Advantages

- Use of two different polarity capillary columns with one MSD.

Hewlett-Packard MSD HP 5971 / 5972

Column OD / ID	Part No.
0.31 mm / 0.20 mm	007233-031-00
0.40 mm / 0.25 mm	007233-040-00
0.45 mm / 0.32 mm	007233-045-00

Spare parts

Vespel ferrule; 1 package (5 units)	007348-005-00
Interface nut; 1 package (5 units)	007236-005-00

Agilent Technologies / Hewlett-Packard MSD Agilent/HP 5973A, 5973N, 5973 inert, 5975

0.31 mm / 0.20 mm	008599-031-00
0.40 mm / 0.25 mm	008599-040-00

Spare parts

Vespel ferrule; 1 package (5 units)	009999-093-00
Interface nut; 1 package (5 units)	007236-005-00



GRAPHPACK® 3D/2 connection technology

For the rapid, reliable and low-dead-volume connection of two capillary columns with the same or different outside diameter, or of different materials.

The components of the GRAPHPACK 3D/2 connection technology are the GRAPHPACK 3D/2 ferrule, the GRAPHPACK 3D/2 connector and the GRAPHPACK 3D/2 screw.

Sulfinert®

All GRAPHPACK 3D/2 components which come into contact with analytes are Sulfinert® coated. This offers the optimal surface material for every GC analysis. Sulfinert is the latest in passivation coating technology, the next generation of the well-known Silcosteel® coating.

The Sulfinert coating is ideal for use in all GC applications such as environmental, flavour and fragrance, off-odors, food and beverage, chemical and petrochemical, pharmaceutical and polymers. Sulfinert is stable over a wide pH range and unlike fused silica coatings, which can dissolve in caustic environments; the Sulfinert coating is stable when sampling caustic amines as well as acidic sulfur compounds.

Sulfinert provides for the determination of ultra-low levels of organic compounds and superior inertness for sulfur compounds, simplifying the choice of passivation surface. When working with GERSTEL® GRAPHPACK 3D/2 products, there is no need to use different passivation surfaces for different applications or different analytes. GERSTEL GRAPHPACK 3D/2 is offered with only one type of surface passivation: The very best.

1 GRAPHPACK 3D/2 ferrule



The GRAPHPACK 3D/2 ferrule is a cylinder metal packed with graphite.

Advantages

- Suitable for high pressures and temperatures as well as high vacuum.
- Rapid mounting and positioning on the column outside the oven.
- Leak-free connections are achieved without excessive tightening.
- Connections remain leak-free with temperature cycling.
- Self-centering of the ferrule in the connector.

3 GRAPHPACK 3D/2 screw

The screw secures the capillary column and the GRAPHPACK 3D/2 ferrule in the connector.

4 GRAPHPACK 3D/2 sealing ferrule

This is a GRAPHPACK 3D/2 ferrule with a fixed sealing wire for the low dead-volume sealing of an outlet which is not needed on GRAPHPACK 3D/2 crosspieces and switching in use.

Advantages

- No dead volume occurs as the result of an outlet which is not needed.
- No graphite enters the GRAPHPACK 3D/2 crosspiece or switching device as an appropriate sealing ferrule is available for every column diameter.

2 GRAPHPACK 3D/2 connectors

IColumn connectors, crosspieces and switching devices for the connection of two to four capillary columns of the same or different diameters.

Advantages

- Low thermal mass.
- Low dead-volume.

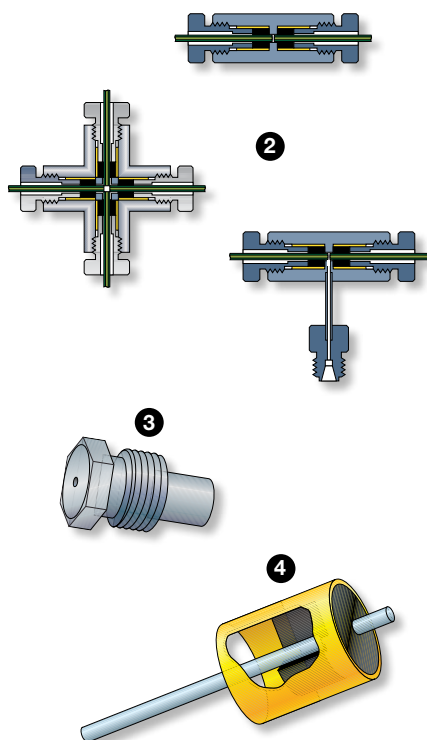

Column OD / ID

Part No.

**GRAPHPACK 3D/2
ferrules**

1 package (10 units)

0.20 mm / ≤ 0.1 mm	001705-020-00
0.25 mm / ≤ 0.1 mm	001705-025-00
0.31 mm / 0.20 mm	001705-031-00
0.40 mm / 0.25 mm	001705-040-00
0.45 mm / 0.32 mm	001705-045-00
0.70 mm / 0.53 mm	001705-007-00
0.80 mm / 0.27 mm	001705-008-00



GRAPHPACK 3D/2 screw

1 package (1 units)

0.20 mm / ≤ 0.1 mm	005615-020-00
0.25 mm / ≤ 0.1 mm	005615-025-00
0.31 mm / 0.20 mm	005615-031-00
0.40 mm / 0.25 mm	005615-040-00
0.45 mm / 0.32 mm	005615-045-00
0.70 mm / 0.53 mm	005615-007-00
0.80 mm / 0.27 mm	005615-008-00

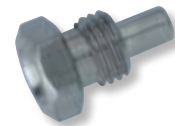

**GRAPHPACK 3D/2
sealing ferrule for
GRAPHPACK 3D/2
crosspieces**

1 package (5 units)

0.20 mm / ≤ 0.1 mm	006520-020-00
0.25 mm / ≤ 0.1 mm	006520-025-00
0.31 mm / 0.20 mm	006520-031-00
0.40 mm / 0.25 mm	006520-040-00
0.45 mm / 0.32 mm	006520-045-00
0.70 mm / 0.53 mm	006520-007-00
0.80 mm / 0.27 mm	006520-008-00



GRAPHPACK® 3D/2 column connector Sulfinert®

For the connection of two capillary columns with the same or different diameters or of different materials.



Column OD / ID	Column OD / ID	Part no.
from 0.70 / 0.53 mm to	0.31 mm / 0.20 mm	013407-031-00
	0.40 mm / 0.25 mm	013407-040-00
	0.45 mm / 0.32 mm	013407-045-00
	0.70 mm / 0.53 mm	013407-007-00
from 0.45 / 0.32 mm to	0.31 mm / 0.20 mm	013445-031-00
	0.40 mm / 0.25 mm	013445-040-00
	0.45 mm / 0.32 mm	013445-045-00
from 0.40 / 0.25 mm to	0.40 mm / 0.25 mm	013440-040-00
from 0.31 / 0.20 mm to	0.31 mm / 0.20 mm	013431-031-00

GRAPHPACK 3D/2 column connector Sulfinert® with gas connection

Spare parts
see page 15

GRAPHPACK 3D/2 column connector with gas connection
For the connection of two capillary columns with the same or different diameters or of different materials and the connection of make-up gas.



Column OD / ID	Column OD / ID	Part no.
from 0.80 to	0.45 mm / 0.32 mm	013508-045-00
from 0.70 / 0.53 mm to	0.31 mm / 0.20 mm	013507-031-00
	0.40 mm / 0.25 mm	013507-040-00
	0.45 mm / 0.32 mm	013507-045-00
	0.70 mm / 0.53 mm	013507-007-00
from 0.45 / 0.32 mm to	0.31 mm / 0.20 mm	013545-031-00
	0.40 mm / 0.25 mm	013545-040-00
	0.45 mm / 0.32 mm	013545-045-00
from 0.40 / 0.25 mm to	0.40 mm / 0.25 mm	013540-040-00
from 0.31 / 0.20 mm to	0.31 mm / 0.20 mm	013531-031-00

GRAPHPACK 3D/2 crosspieces Sulfinert®

For the connection up to 4 capillary columns with the same or different diameters or of different materials.

GRAPHPACK 3D/2 crosspiece kit

contains

- GRAPHPACK 3D/2 crosspiece
- GRAPHPACK 3D/2 ferrules
- Universal bracket for crosspiece
- GRAPHPACK mounting tool kit

main column outside diameter	Part no.
0.31 mm	012224-031-00
0.45 mm	012224-045-00
0.70 mm	012224-007-00



Spare parts

GRAPHPACK 3D/2 crosspiece	0.31 mm	012240-031-00
	0.40 mm	012240-040-00
	0.45 mm	012240-045-00
Universal bracket for crosspiece	0.70 mm	012240-007-00
		006188-000-00

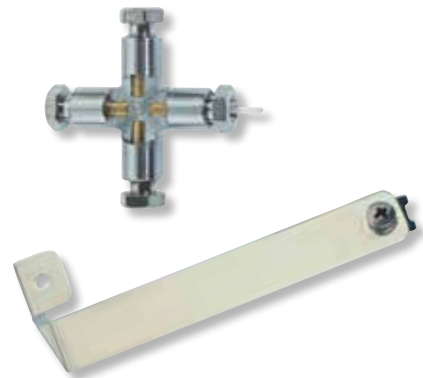

1 GRAPHPACK mounting tool kit for GRAPHPACK 3D/2 column connectors + crosspieces

Complete kit	013492-000-00
--------------	----------------------



Spare parts

2 GRAPHPACK mounting tool tool body without insert

003424-000-00



3 Insert for 1.2 mm column mounting depth

Color red	008994-003-00
-----------	----------------------



4 Insert holder

main column outside diameter	Part no.
0.20 mm to 0.31 mm	008995-031-00
0.40 mm to 0.45 mm	008995-045-00
0.70 mm to 0.80 mm	008995-008-00





GERSTEL

GERSTEL GmbH & Co. KG

Eberhard-Gerstel-Platz 1
45473 Mülheim an der Ruhr
Germany

-  +49 (0) 208 - 7 65 03-0
-  +49 (0) 208 - 7 65 03 33
-  gerstel@gerstel.com
-  www.gerstel.com

GERSTEL Worldwide

GERSTEL, Inc.

701 Digital Drive, Suite J
Linthicum, MD 21090
USA

-  +1 (410) 247 5885
-  +1 (410) 247 5887
-  sales@gerstel.com
-  www.gerstel.com

GERSTEL AG

Wassergrabe 27
CH-6210 Sursee
Switzerland

-  +41 (41) 9 21 97 23
-  +41 (41) 9 21 97 25
-  swiss@ch.gerstel.com
-  www.gerstel.ch

GERSTEL K.K.

1-3-1 Nakane, Meguro-ku
Tokyo 152-0031
SMBC Toritsudai Ekimae Bldg 4F
Japan

-  +81 3 5731 5321
-  +81 3 5731 5322
-  info@gerstel.co.jp
-  www.gerstel.co.jp

GERSTEL LLP

10 Science Park Road
#02-18 The Alpha
Singapore 117684

-  +65 6779 0933
-  +65 6779 0938
-  SEA@gerstel.com
-  www.gerstel.com

GERSTEL Brasil

Av. Pascoal da Rocha Falcão, 367
04785-000 São Paulo - SP Brasil

-  +55 (11)5665-8931
-  +55 (11)5666-9084
-  gerstel-brasil@gerstel.com
-  www.gerstel.com.br

Information, descriptions and specifications in this Publication are subject to change without notice.

Ver. 2015/06/17

To download the latest version, please go to : www.gerstel.com/en/supplies.htm

GERSTEL, GRAPHPACK and TWISTER are registered trademark of GERSTEL GmbH & Co. KG

©Copyright by GERSTEL GmbH & Co.KG

Agilent is trademark of Agilent Technologies, Inc.; Carbotrap B and Carbotrap C are trademarks of Sigma-Aldrich Biotechnology L.P.; HP is trademark of Hewlett-Packard Development Company, L.P.; Kalrez® and Viton® are trademarks of Dupont Performance Elastomers; Teflon® is trademark of E. I. Du Pont de Nemours & Company; Tenax® TA is trademark of Buchem B.V.



Awarded for the active pursuit of

S00135-703-02