

**GERSTEL**

AppNote 3/2007

Headspace Sampling Unit Combined with a Metal Oxide Sensor or Standard Detectors for Quantification of VOC Emissions from Beverage Cans or Other Packaging Materials

Eike Kleine-Benne
*Gerstel GmbH & Co.KG, Eberhard-Gerstel-Platz 1,
D-45473 Mülheim an der Ruhr, Germany*

Horst Peter Kühl
*Ball Packaging Europe GmbH, Friedrich-Wöhler-Straße 51,
D-53117 Bonn, Germany*

Michael Blaschke
*AppliedSensor GmbH, Gerhard Kindler Str. 8,
D-72770 Reutlingen, Germany*

KEYWORDS

Beverage, Detector, Headspace, Quality Control

INTRODUCTION

The quality of packaging materials used in the food and beverage industry must be controlled regularly in order to avoid negative effects on packaged products caused by emissions, e.g. VOC emissions from printing processes or from varnishes used on inner surfaces of the packaging material. Many companies have worldwide production sites, that may not all have their own quality control laboratories. Therefore VOC emissions can not necessarily be measured at-line and production process development is often halted due to the lack of analytical data. A headspace sampler is presented that can be combined either with a classic GC detector like an FID for quickly measuring thresholds as summed parameters to release a batch of a product or with metal oxide sensors, e.g. to monitor production processes at-line. A major benefit of metal oxide sensors is that they operate without combustion gases, enabling their use on production

sites. Furthermore, the presented headspace sampler can be equipped with a transfer line to couple it e.g. to GC/MS for further investigations in the laboratory.

The headspace sampler design enables direct sampling from closed food and beverage packaging. The system contains no 6-port valve and is therefore highly robust and well suited for regular transportation.

An application is presented using all available configurations of the system for the determination of VOC-emissions from the inner varnish of beverage cans. The beverage cans are taken straight from the production line without any treatment or modification. The system is calibrated using ethanol, determination of response factors for all relevant compounds against the ethanol calibration therefore have to be known in order to determine the VOC emissions.

INSTRUMENTATION

The aim was to develop a dedicated system for measuring total VOC-emissions from surfaces of packaging materials (including inner surfaces). The system must be simple to handle allowing to be used by unskilled persons at the production line. Therefore the design is based on a valveless single shot headspace sampling unit together with a simple detector. An online FID or a MOX-sensor was chosen in this case. The sample introduction also has to be very simple to perform, which means in this case that taking headspace samples from a beverage can has to be possible without further manipulations like cutting the can in pieces and putting them in special headspace vials.



Figure 1. Quality Control System QCS 1 – Headspace Sampling System for beverage cans, in this configuration equipped with a Flame Ionization Detector FID; 1 optional printer, 2 sample oven, 3 control panel, 4 optional FID.

The heart of the system is its sample flow path from the sample to the detector via the sample loop. Pressure regulator PR1 together with solenoid valve SV1 as well as pressure regulator PR 2 together with solenoid valve SV2 are used to regulate the pressure in the whole system. The flow diagram in Fig. 2 shows the valveless headspace system and all relevant components.

Two pressure regulators are needed to switch between two pressure levels without using expensive electronic pressure regulators. Instead of valves two

restrictions are installed in the flow path. One restrictor is installed directly in front of the sample. It is used to prevent a loss of analytes due to diffusion, and to prevent a pressure drop in the system when the sample is removed. The second restriction is installed between the sample loop and the sensor chamber. This restriction is needed when the sample loop is filled and it can be replaced by a chromatographic column as needed.

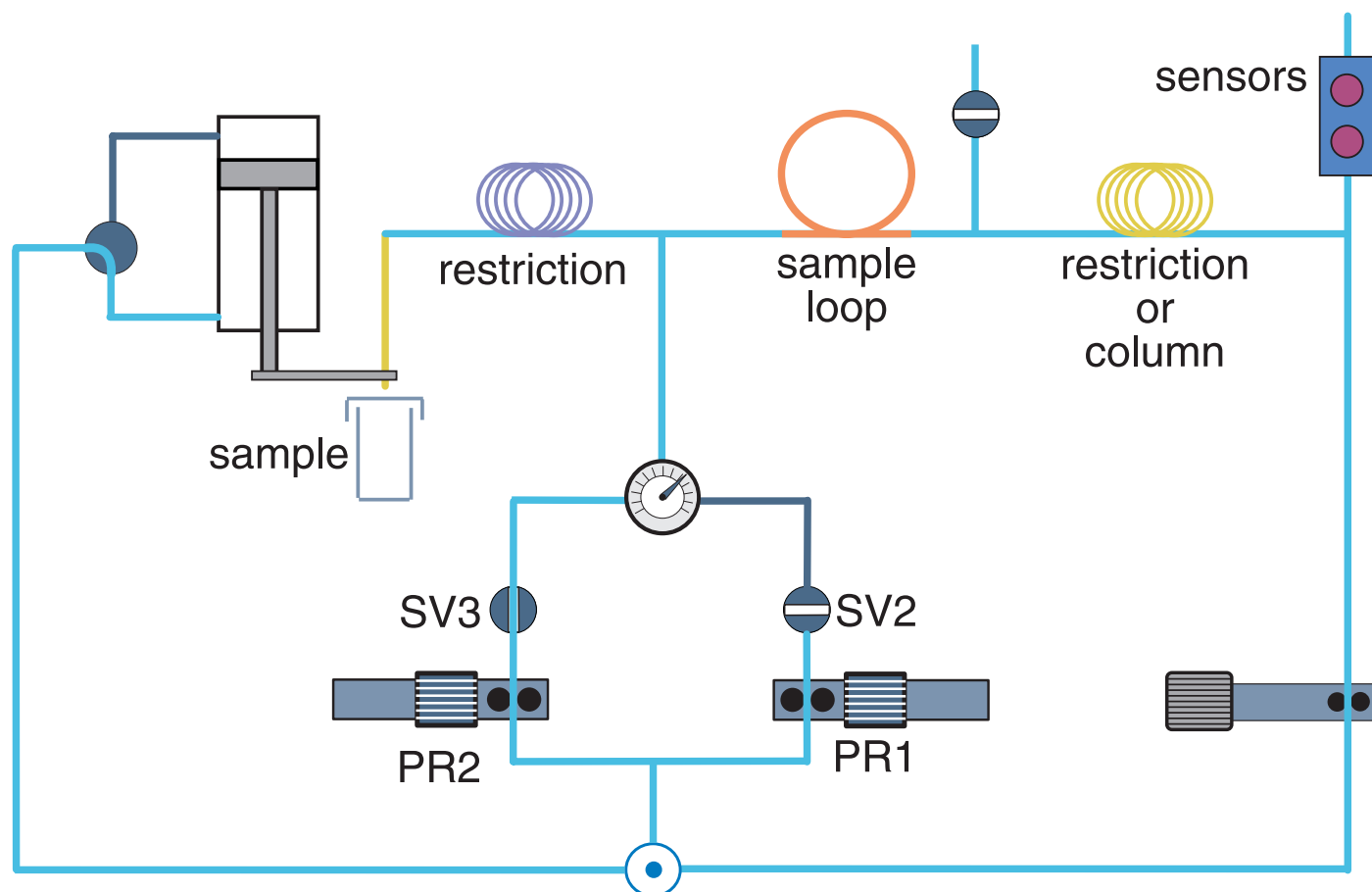

Figure 2. QCS 1- flow diagram of the valveless headspace sampling technique.

Without a column the system is similar to common laboratory set-ups using commercial headspace samplers as sample introduction systems for electronic sensor systems. For the investigations presented in this paper, a short 3 m DB 5 MS column was used. Using such a short column, no analyte separation is achieved but organic components are retained a bit before entering the detector. This delay of the analytes helps in providing a few seconds more signal base line at the beginning of the analysis thereby enabling reliable automatic peak integration. In this configuration, pressure switching is timed such that it does not affect the analyte signal.



Figure 3. QCS 1 - Sample Oven for beverage cans. The picture shows the open oven with a beverage can inserted bottom-up. In the middle of the open oven lid a septum screw is seen. This septum screw presses the septum onto the convex bottom of the beverage can. Because of the conical shape the septum fits all type of beverage cans or other solid vessels. The extra hardened headspace needle penetrates the septum and the metal bottom of the can.

EXPERIMENTAL

Detection with FID. A first instrumental approach was to equip the headspace sampler with an FID. This was done in order to facilitate comparisons with results from previous determinations of VOC emissions from the inner varnish of beverage cans that were obtained using headspace GC/FID systems. Response factors for all relevant components against ethanol calibration are known and a threshold of 1 ppm for total VOC emissions calibrated against ethanol is known not to affect product quality

QCS 1 capillary dimensions.

Restriction: 48 cm stainless steel, $d_i = 0.2$ mm
 Column: 3 m DB 5 MS
 $d_i = 0.25$ mm $d_f = 0.25$ μ m
 Sample loop: 2 mL

QCS 1 headspace parameters.

Temperatures: 150°C sample
 150°C sample loop
 150°C column
 Times: 2 min equilibration
 1 min sample pressurization
 0.5 min sample loop filling
 2.1 min total analysis
 0.2 min purge
 0.05 min decompression
 Pneumatics: He, P1 =100 kPa, sampling
 He, P2 =50 kPa, analysis

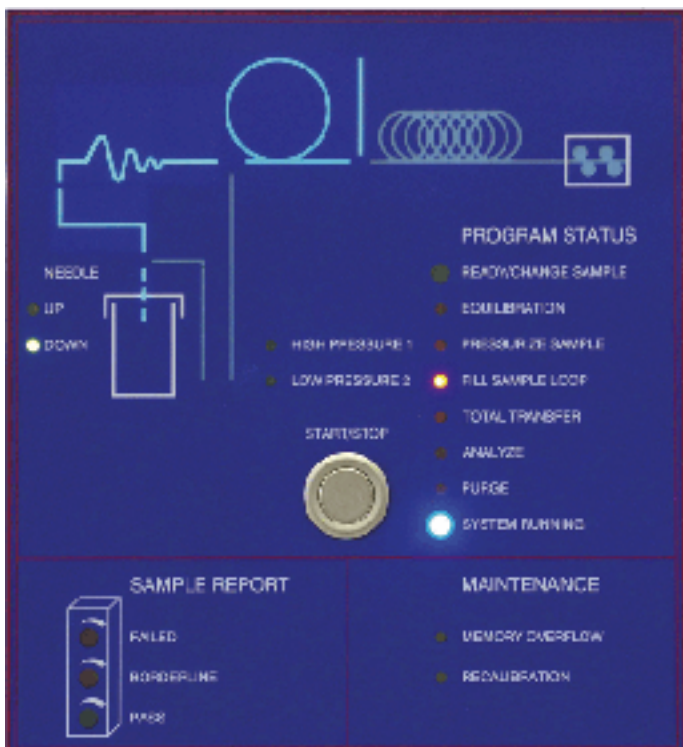

Figure 4. QCS 1 – Instrument Control Panel.

Figure 5 shows a typical FID signal obtained when the headspace sampler is coupled directly to the FID without chromatographic separation.

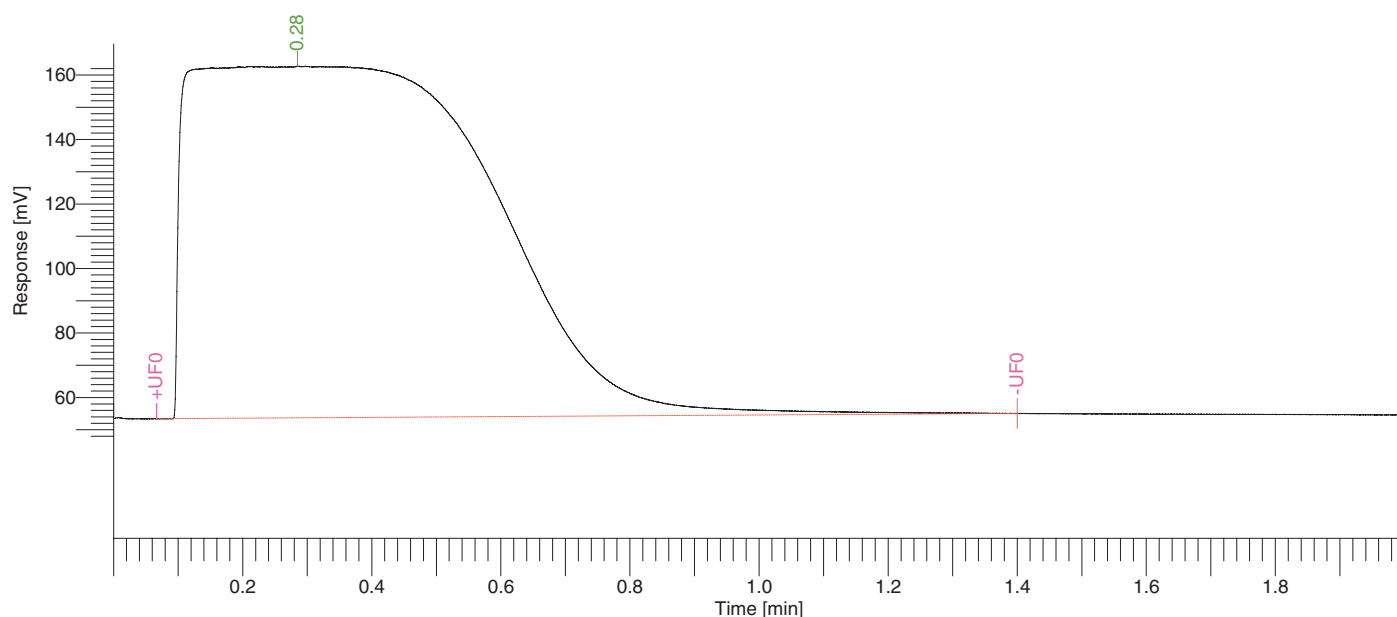

Figure 5. FID Signal, calibration run with 0.3 μ L ethanol added to a 330 mL empty and blank can.

Figure 6 shows a calibration of the FID signal with liquid ethanol injections into an empty and blank can. Because of the direct sample introduction without chromatographic separation or distribution it was important to determine if calibration via signal height or peak area leads to different results. As shown in Fig. 6 both calibration procedures provide excellent results.

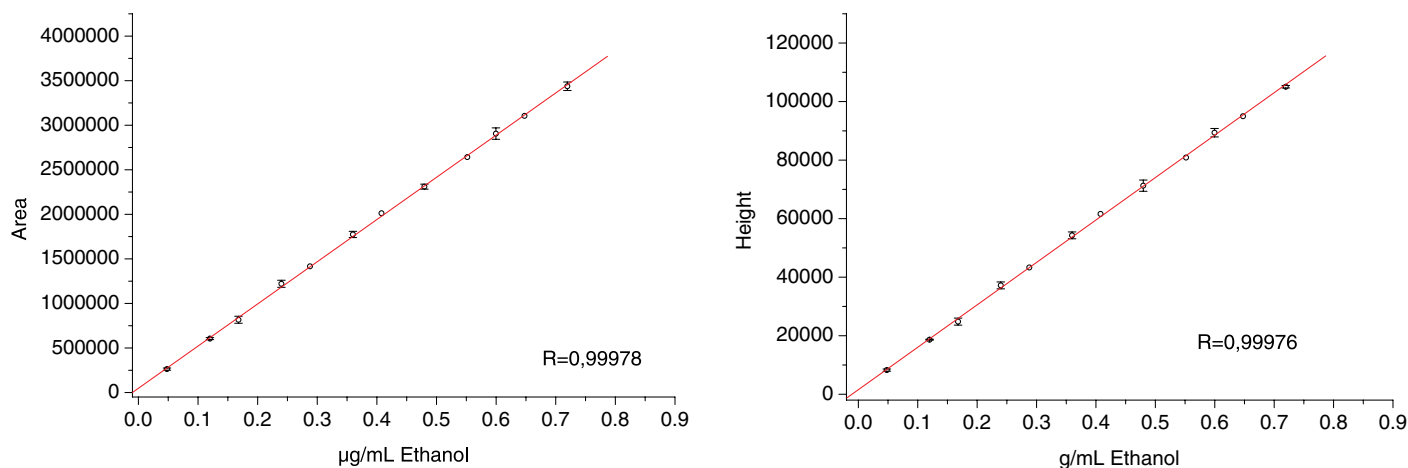

Figure 6. Calibration of the FID with liquid injection of ethanol in an empty and blank calibration can. Liquid injections varied between 0.02 to 0.3 μ L, can volume was 330 mL. The shown error bars result from 2 injections at each level.

Detection with MOX Sensor. A second approach was to equip the headspace sampler with a metal oxide sensor (MOX sensor). A micro-machined sensor from Applied Sensors GmbH (Germany) was used in this study. The sensor acts as a detector for reducing gases and has proven to be relatively non-selective for different hydrocarbons. This means that such a sensor can be a substitute for an FID and it only requires synthetic air for operation, no further combustion gases, enabling the use of the system as a quality control tool near or at the production line. For all experiments with the sensor-based system synthetic air was used as carrier gas.

Figure 7 shows a typical MOX signal from a calibration run with ethanol. The signal curve shows a less rectangular shaped front than the FID signal. This is due to two effects: the sensor chamber has more dead volume than the FID leading to dispersion of the sample gas and a sensor usually responds slower.

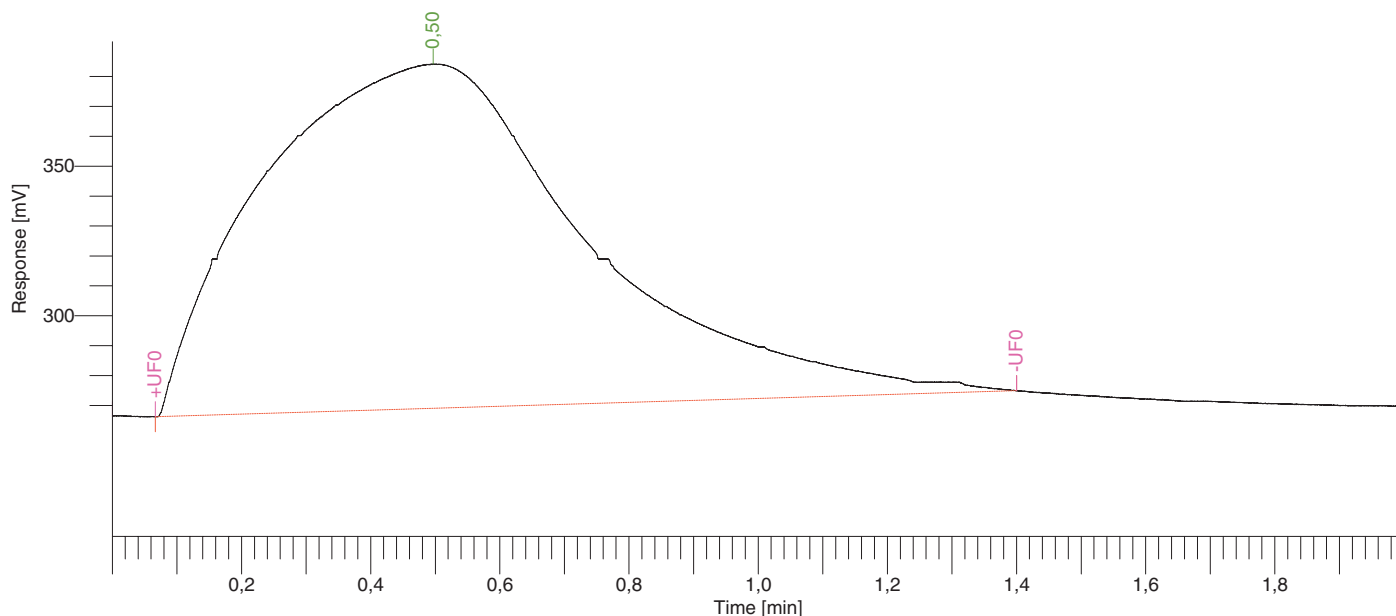

Figure 7. Sensor Signal, calibration run with 0.3 µL ethanol added to a 330 mL empty and blank can.

Figure 8 shows the calibration curve of the sensor for ethanol. Normally the signal of MOX sensors follows the non-linear function $y = a + b \cdot x^c$ ($x = \text{“analyte concentration”}$) whereas the parameter “c” shows values between 0.2 and 0.5. This function was used for regression analysis for peak area as well as for peak height. As seen in figure 8, these approaches to signal calibration give similar results.

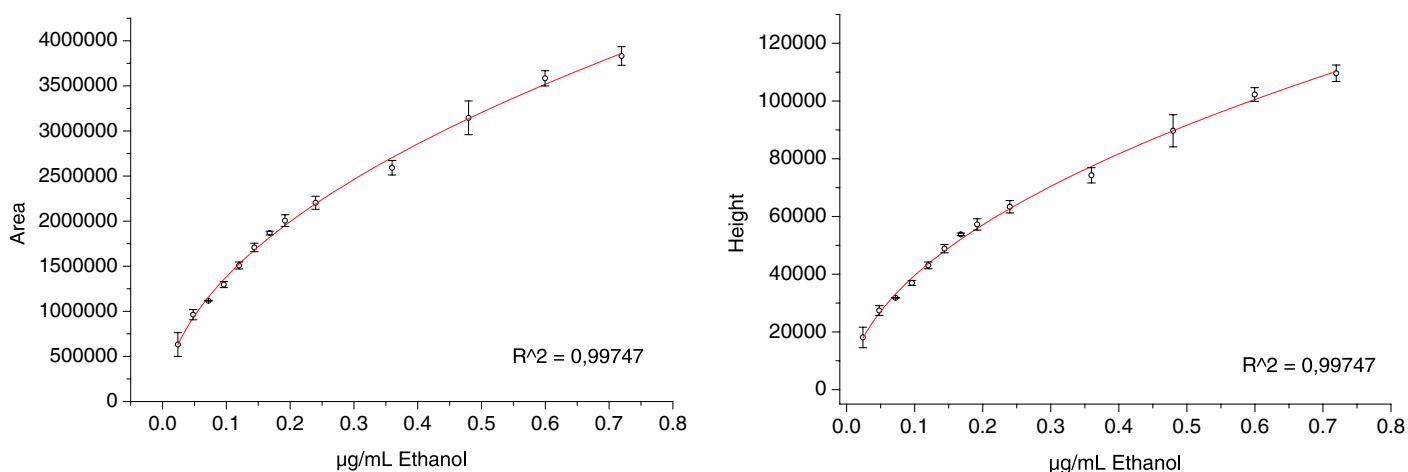

Figure 8. Calibration of the Sensor with liquid injection of ethanol in an empty and blank calibration can. Liquid injections varied between 0.01 to 0.3 µL, can volume was 330 mL. The shown error bars result from 3 injections atn each level.

Special Configuration – GC/MS Coupling. Configured with an FID or a MOX sensor, the QCS 1 is a useful tool to measure total VOC emissions as a summed parameter. This enables process control departments to assure that VOC emissions do not exceed a given threshold level. When more detailed information is needed, a transferline e.g. to a GC/MS can be installed instead of the FID or MOX-sensors. A special operation mode closes the valve that normally allows the overpressure to fill the sample loop. This results in a transfer of pressurized sample gas to the GC inlet. Depending on the sample vessel volume a few milliliters up to a few

hundred milliliters of sample gas can be transferred. Using a cryotrap, for example a GERSTEL CIS inlet, enables enrichment of emitted VOC and an even more detailed investigation of the emitted compounds. The following figure shows a GC/MS chromatogram of a headspace sample from a beverage can obtained with this instrument configuration. The inner surface of this can was covered with a varnish based on a polyacrylate. Total VOC emission from the inner surface of this can was below 1 ppm. When the QCS 1 is coupled to a GC/MS system, all relevant compounds can be identified and determined individually.

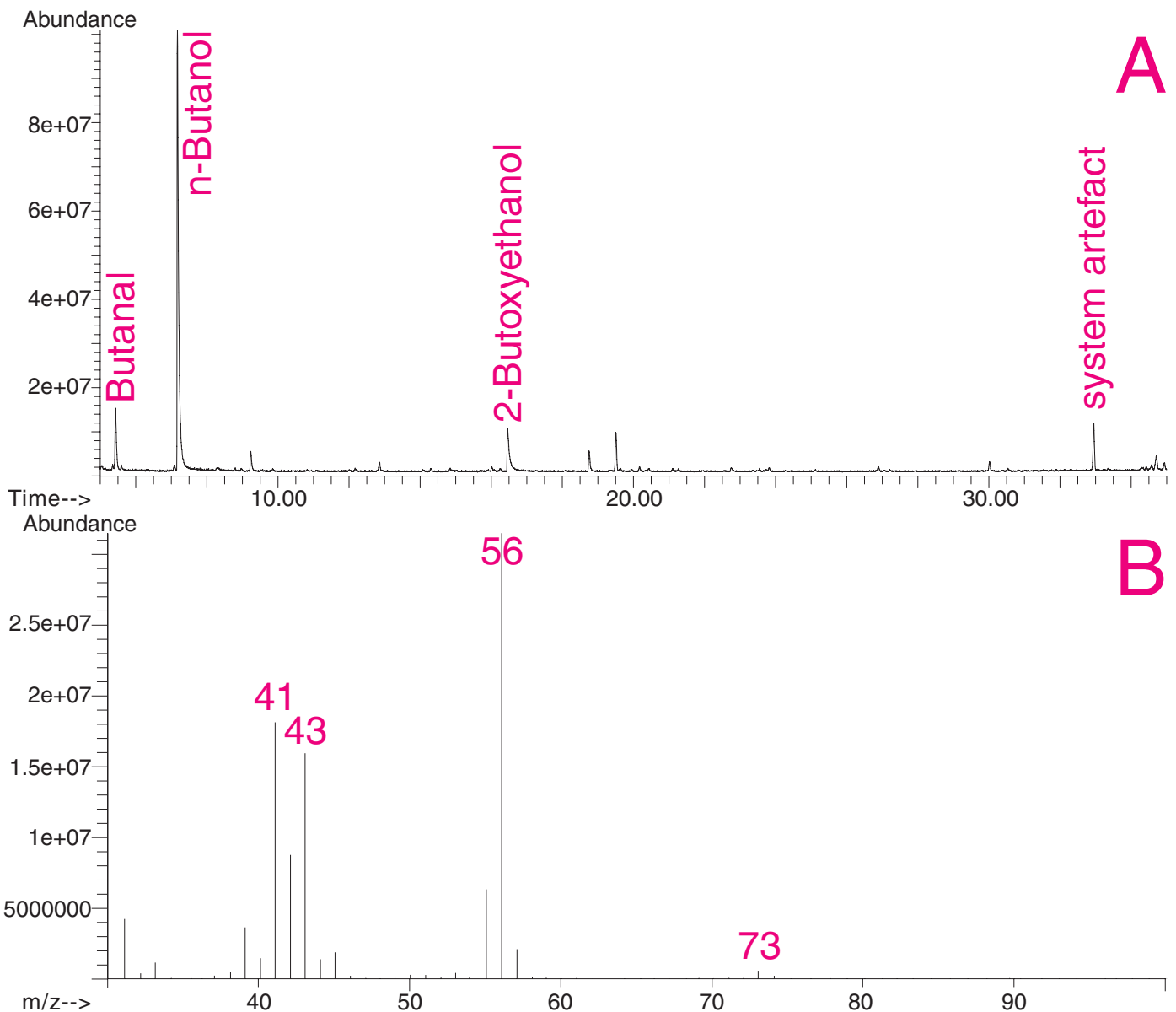

Figure 9. MSD Chromatogram obtained from a QCS 1 – GC/MSD coupling. Sample: beverage can with total VOC emissions from the inner varnish below 1 ppm.

CONCLUSION

A Headspace Sampler for bigger sample sizes has been developed that can be used as a Quality Control System near or at the production line to measure total VOC emissions from packaging materials, e.g. from the inner varnish of beverage cans. The following is a list of the main features:

- Single shot headspace sampler based on Deans switching principle (no valves in sample flow path)
- Sampling Temp. max 200°C, Transfer Temp. max 200°C
- Integrated MOX-Sensors allow total hydrocarbon determination (Stand alone analyzer for production site)
- Instead of sensors a stand alone FID can be used
- Sample sizes from 10 mL Headspace vials up to 0.5 L beverage cans is possible by simply exchanging the sample chamber
- Sampling out of closed beverage cans is possible
- Integration of separation column if necessary (e.g. separating water and organic components with sorbitol column, which is sometimes important for MOX sensor detection)
- Total transfer of the pressurized sample e.g. for enrichment in a CIS for GC/MS analysis is possible



GERSTEL

GERSTEL GmbH & Co. KG
Eberhard-Gerstel-Platz 1
D-45473 Mülheim an der Ruhr

☎ +49 (0) 208 - 7 65 03-0
☎ +49 (0) 208 - 7 65 03 33

@ gerstel@gerstel.com
🌐 www.gerstel.com

GERSTEL Inc.
701 Digital Drive, Suite J
Linthicum, MD 21090

☎ +1 (410) 247 5885
☎ +1 (410) 247 5887

@ info@gerstelus.com
🌐 www.gerstelus.com

GERSTEL GmbH & Co. KG
Technisches Büro Berlin
Marburger Straße 3
10789 Berlin

☎ (0 30) 21 90 98 28
☎ (0 30) 21 90 98 27

@ tb_berlin@gerstel.de

GERSTEL AG
Enterprise
Surenalstrasse 10
CH-6210 Sursee

☎ +41 (41) 9 21 97 23
☎ +41 (41) 9 21 97 25

@ gerstel@ch.gerstel.com
🌐 www.gerstel.de

GERSTEL GmbH & Co. KG
Technisches Büro Bremen
Parkallee 117
28209 Bremen

☎ (04 21) 3 47 56 24
☎ (04 21) 3 47 56 42

@ tb_bremen@gerstel.de

GERSTEL K. K.
2-13-18 Nakane, Meguro-ku
Dai-Hyaku Seimei Toritsudai Ekimae Bldg 2F
152-0031 Tokyo

☎ +81 3 5731 5321
☎ +41 3 5731 5322

@ info@gerstel.co.jp
🌐 www.gerstel.co.jp

GERSTEL GmbH & Co. KG
Technisches Büro Karlsruhe
Greschbachstraße 6a
76229 Karlsruhe

☎ (07 21) 9 63 92 10
☎ (07 21) 9 63 92 22

@ tb_karlsruhe@gerstel.de

GERSTEL GmbH & Co. KG
Technisches Büro München
Stefan-George-Ring 29
81929 München

☎ (04 21) 3 47 56 24
☎ (04 21) 3 47 56 42

@ tb_bremen@gerstel.de

GERSTEL, GRAPHPACK und TWISTER
sind eingetragene Warenzeichen der
GERSTEL GmbH & Co. KG
Änderungen vorbehalten

Information, descriptions and specifications in this
Publication are subject to change without notice.
GERSTEL, GRAPHPACK and TWISTER are
registered trademarks of GERSTEL GmbH & Co. KG.

Printed in the Rep. of Germany

© Copyright by GERSTEL GmbH & Co. KG

